

**MARK SCHEME for the May/June 2014 series**

**0420 COMPUTER STUDIES**

**0420/11**

Paper 1, maximum raw mark 100

This mark scheme is published as an aid to teachers and candidates, to indicate the requirements of the examination. It shows the basis on which Examiners were instructed to award marks. It does not indicate the details of the discussions that took place at an Examiners' meeting before marking began, which would have considered the acceptability of alternative answers.

Mark schemes should be read in conjunction with the question paper and the Principal Examiner Report for Teachers.

Cambridge will not enter into discussions about these mark schemes.

Cambridge is publishing the mark schemes for the May/June 2014 series for most IGCSE, GCE Advanced Level and Advanced Subsidiary Level components and some Ordinary Level components.

<b>Page 2</b>	<b>Mark Scheme</b>	<b>Syllabus</b>	<b>Paper</b>
	<b>IGCSE – May/June 2014</b>	<b>0420</b>	<b>11</b>

1 (a) 1 mark for correct name + 1 mark for correct corresponding diagram.

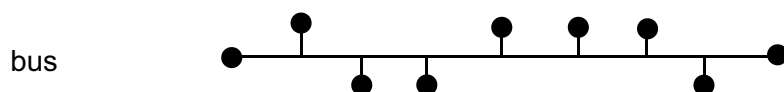

[4]

(b) Any **two** from:

- shared resources
- better/easier communications
- easier to “keep track” of users from a central point
- all computers/users can share same data/programs (stored on a central database)/easier transfer of data between computers
- can access your files from any computer on the network

[2]

(c) Any **one** from:

- greater risk of spreading viruses to other computers/the network
- increased security risks when computers connected together
- failure of server affects all stations

[1]

<b>Page 3</b>	<b>Mark Scheme</b>	<b>Syllabus</b>	<b>Paper</b>
	<b>IGCSE – May/June 2014</b>	<b>0420</b>	<b>11</b>

- 2 (a) (i) Any **one** from:
- airline bookings need to be done in real time to stop double bookings
  - batch processing only done at the end of the day/week so double booking is possible
- [1]

- (ii) Any **one** from:
- GUI uses pointing devices/icons/windows (mouse, trackerball, .....)
  - keyboard used with command line interfaces
- [1]

- (b) Any **four** functions from:
- file management/delete/copy/save/store/load files
  - controls/manages software/hardware
  - memory management
  - I/O control
  - error messages/handling
  - security issues
  - logging on/off
  - accounting/user account management
  - time slicing
  - multi access
  - multi tasking/task management
  - JCL/job control/batch processing
  - network management
- [4]

3 1 mark for naming validation check + 1 mark for correct matching example

<b>field name</b>	<b>name of validation check</b>	<b>example of data which would fail validation check</b>
<b><i>date of visit</i></b>	format check	e.g. 2012/12/04 e.g. 3rd March 2012
<b><i>patient's height</i></b>	type/character check range check limit check	can't be < 0 or > 2.5m e.g. -5, five e.g. 8, -3,
<b><i>patient ID</i></b>	type check length check range check	(can't be < 0 or > 99999999) e.g. 3142ABCD e.g. 2131451, 136498207  e.g. -3, 851341625
<b><i>contact telephone number</i></b>	length check type/character check format check	e.g. 0773141621834 e.g. 7H215GD e.g. 01223/123456/8901234

[8]

<b>Page 4</b>	<b>Mark Scheme</b>	<b>Syllabus</b>	<b>Paper</b>
	<b>IGCSE – May/June 2014</b>	<b>0420</b>	<b>11</b>

4 1 mark for each correct arrow up to the maximum of 5 marks.

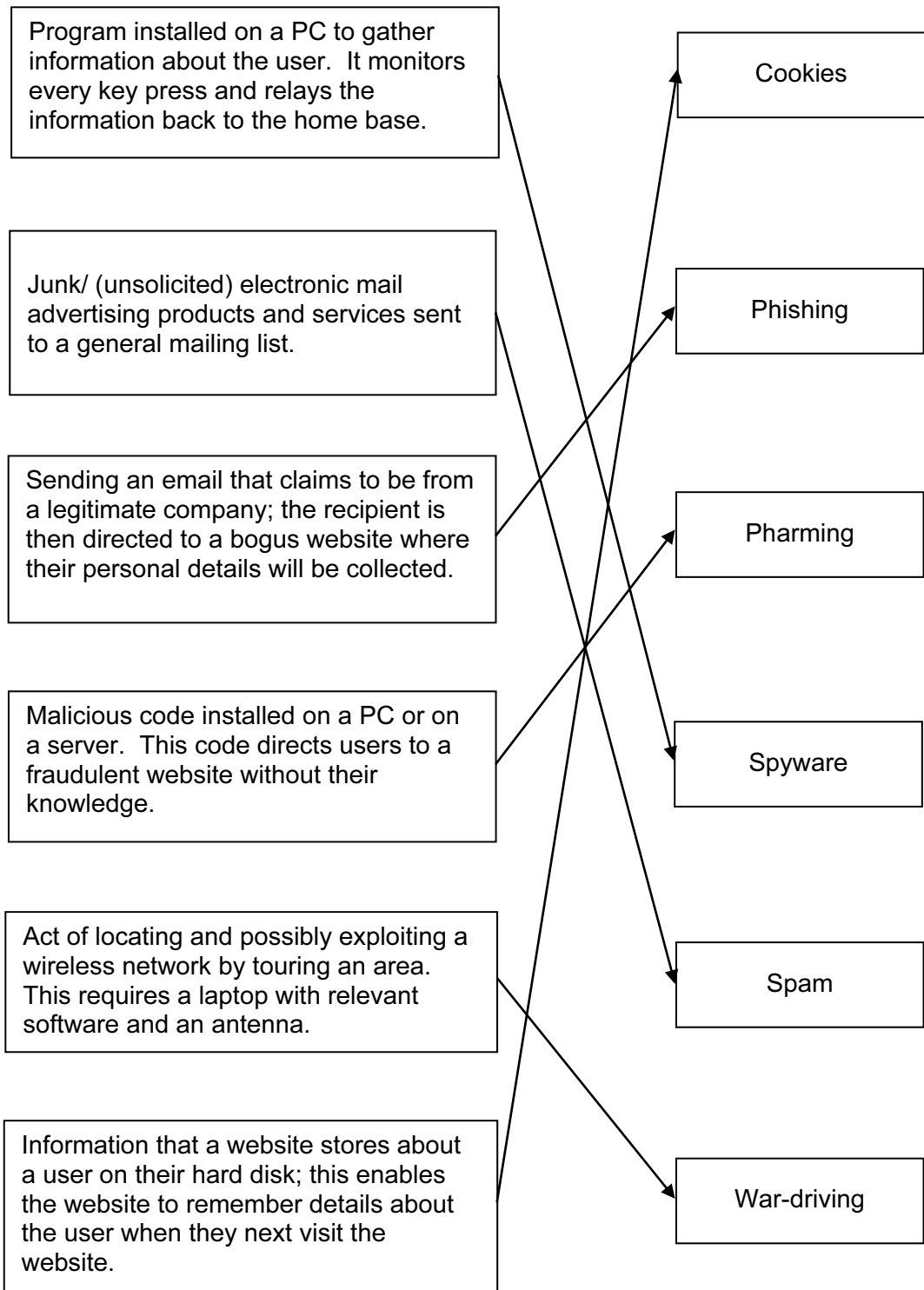

[5]

Page 5	Mark Scheme	Syllabus	Paper
	IGCSE – May/June 2014	0420	11

**5** *pendown*

**left 45**

-----  
forward 28  
right 45 (1 mark)

-----  
forward 20  
right 135 (1 mark)

-----  
forward 28  
left 90 (1 mark)

-----  
forward 28  
right 135 (1 mark)

-----  
forward 20  
right 45 (1 mark)  
forward 28

-----  
(*penup*)  
(*left 45*)

[5]

**6 (a)** Any **two** from:

- any reference to cost saving plus reason
- any reference to time saving plus reason
- possible to order 24/7
- goods delivered to customer's house (may be heavy/large goods)
- customers who don't live in Europe can buy goods

[2]

**(b)** Any **two** from:

- use of cookies (to find customer preferences)
- open 24/7
- wider customer base (potentially)

[2]

**(c)** Any **three** from:

- possible redundancies
- need to re-train/learn new skills/job role within company can change
- possibility of working from home
- relocation of certain staff (to a different warehouse)
- **increased** health risk to staff due to more computer-based work

[3]

(d) Any **two** from:

- secure payment method
- shopping basket
- checkout
- search facility
- “remember customer”/log in
- customers who bought “X” also bought “Y” facility
- hyperlinks to other pages/websites
- currency converter
- create customer account
- description of the products for sale
- contact details

[2]

7 (a) 1 mark per correct logic gate (accept other gate symbols)

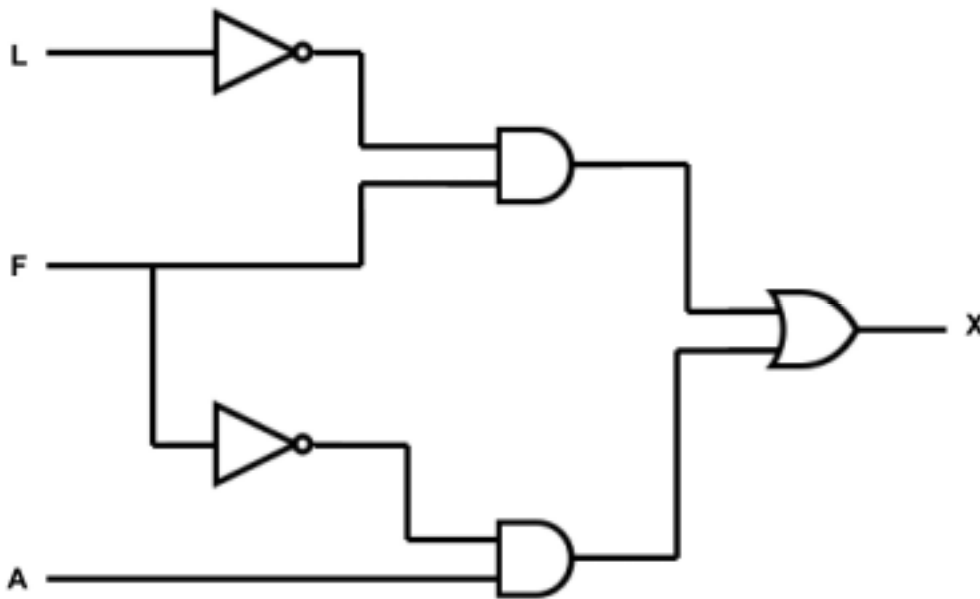

[5]

(b)

L	F	A	X
0	0	0	0
0	0	1	1
0	1	0	1
0	1	1	1
1	0	0	0
1	0	1	1
1	1	0	0
1	1	1	0

1 mark

1 mark

1 mark

1 mark

[4]

<b>Page 7</b>	<b>Mark Scheme</b>	<b>Syllabus</b>	<b>Paper</b>
	<b>IGCSE – May/June 2014</b>	<b>0420</b>	<b>11</b>

8 1 mark per correct column.

number	product	value	OUTPUT
5	1	5	
(5)	5	4	
(5)	20	3	
(5)	60	2	
(5)	120	1	
(5)	(120)	0	
			5, 120

[4]

9 (a) 1 mark for correct formula in cell D2, 1 mark for correct formula replication D2 to D7, 1 mark for correct formula in G2 and 1 mark for correct formula replication from G2 to G7 (allow follow through in both columns D and G).

	<b>D</b>	<b>G</b>
<b>1</b>	<b>Volume change (litres)</b>	<b>Pressure change (bar)</b>
<b>2</b>	= C2 – B2	= F2 – E2
<b>3</b>	= C3 – B3	= F3 – E3
<b>4</b>	= C4 – B4	= F4 – E4
<b>5</b>	= C5 – B5	= F5 – E5
<b>6</b>	= C6 – B6	= F6 – E6
<b>7</b>	= C7 – B7	= F7 – E7

Accept formulas such as:

SUM(C2 – B2)

(or any example that actually works)

[4]

Page 8	Mark Scheme	Syllabus	Paper
	IGCSE – May/June 2014	0420	11

- (b) B1/2 to B7 }  
C1/2 to C7 } 1 mark
- G1/2 to G7 } 1 mark

[2]

- (c) = SUM(D2:D7)/6 or  
= AVERAGE(D2:D7) or  
= AVERAGE(D2,D3,D4,D5,D6,D7) or  
= (D2 + D3 + D4 + D5 + D6 + D7)/6

[1]

- (d) = MAX(G2:G7) or  
= MAX(G2,G3,G4,G5,G6,G7)

[1]

- 10 1 mark for each benefit and 1 mark for each drawback (maximum of 2 marks for each communication method).

**mobile phones**

**benefit:**

- wireless system (so can be used anywhere)
- small, portable device/always with you
- instantaneous (e.g. take photo and immediately transfer file)
- can leave messages if recipient not available

**drawback:**

- contracts tend to be expensive
- phone calls overseas are very expensive
- out of signal
- battery life poor
- data transfer rate can be slow
- not very large memories
- small screens/keyboards make it more difficult to type/navigate

**video conferencing**

**benefit:**

- many people can take part in conference across the world
- can see all delegates on screen (and also talk in synchronised way)
- relatively inexpensive since uses Internet for communications
- can hold meeting of several people at short notice
- no need to pay for travelling/hotels/meeting rooms
- less time wasted travelling to meetings overseas/staff not out of office
- safer – recent increased risk of terrorist attacks

**drawback:**

- equipment is expensive to buy initially
- quality of sound/picture can be poor (poor reception)
- problems with time zones
- fast internet connection required



<b>Page 9</b>	<b>Mark Scheme</b>	<b>Syllabus</b>	<b>Paper</b>
	<b>IGCSE – May/June 2014</b>	<b>0420</b>	<b>11</b>

**emails:**

**benefit:**

- can send at any time/recipient can open any time
- inexpensive (same cost worldwide)
- can send large multimedia files
- no need for expensive equipment
- can send to multiple recipients
- can use attachment facility

**drawback:**

- if recipient doesn't have correct software, can't open attachments
- possibility of virus infections/phishing from attachments
- need Internet connection/ISP
- may not get immediate response (ONLY IF REVERSE NOT GIVEN UNDER BENEFIT) [6]

**11 (a)** Any **two** from:

- “always on” (no need to dial up each time)
- allows telephones to be used at same time as computer in use
- much faster data transfer rate
- dial up charges per minute of use [2]

- (b) (i)** 1 megabits/second = 0.125 Mbyte/second  
 20 Mbyte file takes 20/0.125 seconds  
 i.e. **160 seconds**

(if final answer is incorrect, allow 1 mark for calculation) [2]

- (ii)** 8 megabits/second = 1 Mbyte/second  
 20 Mbyte file takes 20/1 seconds  
 i.e. **20 seconds**

allow b(i) divided by 8 as follow through [1]

**(c)** 1 mark for each advantage and 1 mark for each disadvantage

**advantages:**

- no trailing wires
- can use equipment anywhere (if in range)
- reduced costs since less cabling required

**disadvantages:**

- limited range
- can be blocked by walls/other obstacles
- increased security risk if not password protected
- slower data transfer rate [2]

12 (a)

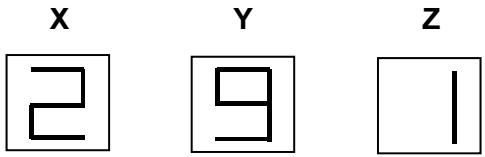

[3]

(b)

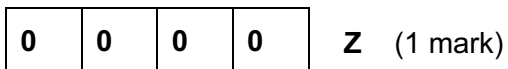
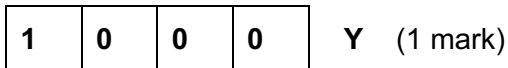

[3]

(c) (i) E, E, E  
Flashing display/digits  
ERR

(or the equivalent answer)

[1]

(ii) Any **one** from:  
– a fault in the system  
– reading exceeded the value 999

[1]

13

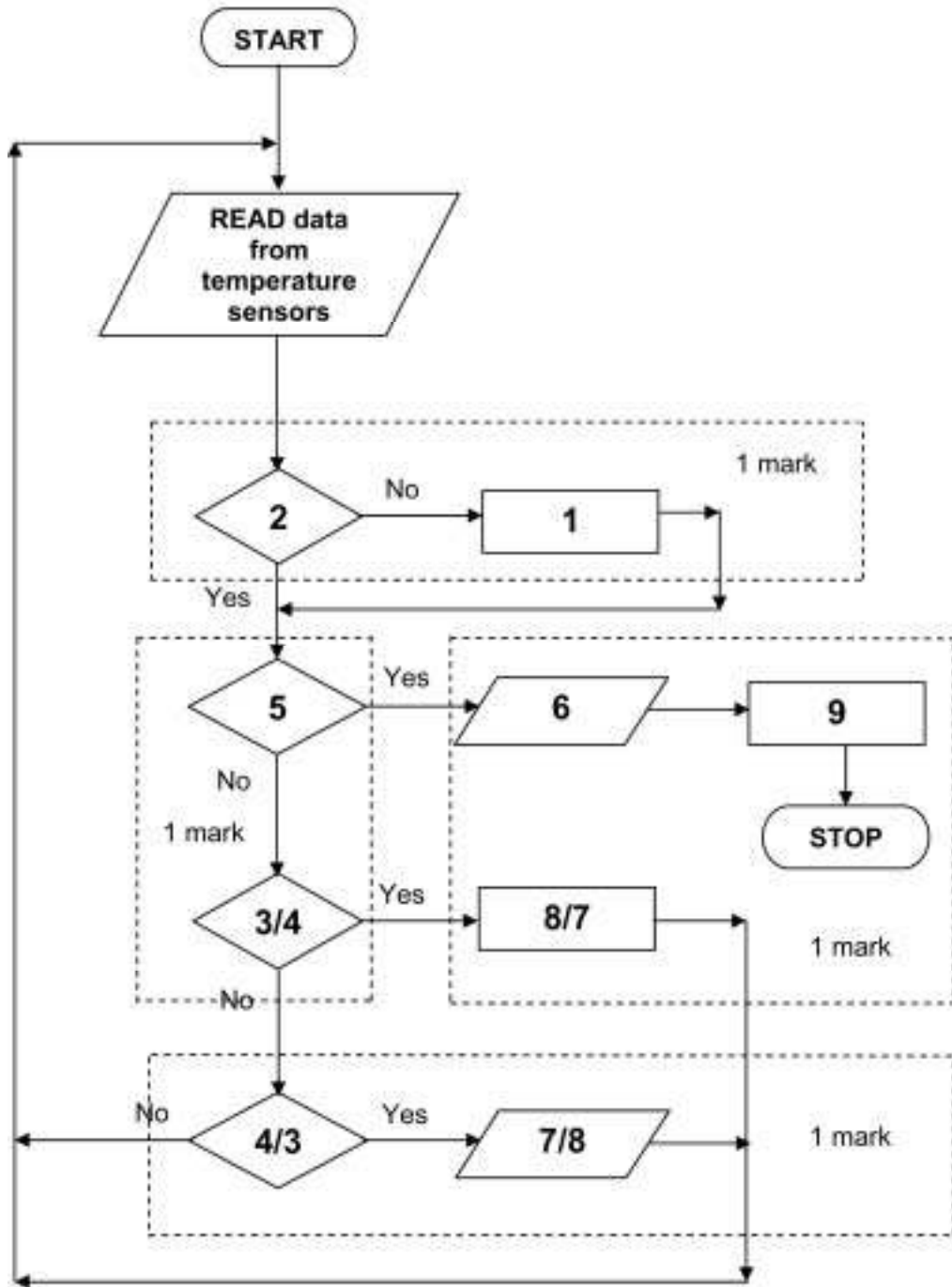

(3 and 8 AND 4 and 7 MUST be marked in PAIRS)  
(accept the phrases)

[4]

Page 12	Mark Scheme	Syllabus	Paper
	IGCSE – May/June 2014	0420	11

- 14 (a) (i) 9 [1]  
(ii) 7 [1]
- (b) OR, CO, NJ, AK, NV [2]  
(–1 mark for each error: i.e. each omission, each incorrect additional item)
- (c) (Area(sq miles) > 100 000) AND (Travel time to work (min) < 25) [2]  
<----- 1 mark -----> <----- 1 mark ----->  
Or  
(Travel time to work (min) < 25) AND (Area(sq miles) > 100 000) [2]  
<----- 1 mark -----> <----- 1 mark ----->
- (i) Ref or Name of State [1]  
(ii) this is unique to for each state [1]

15 possible marking points:  
(award marks for each point up to the maximum of 6)

- initialisation
- inputs in the right place
- correct loop (while or repeat)
- adding up sound levels
- finding highest/loudest sound level
- counting number of sound levels which have been input
- finding the average value
- correct outputs (OUTSIDE loop and needs some previous processing)

sample program:

```
total = 0: highest = 0: count = 0           (1 mark)

input sound                               (1 mark)

while sound > 0 do                         (1 mark)
    total = total + sound                   (1 mark)
    if sound > highest then highest = sound (1 mark)
    count = count + 1                       (1 mark)
input sound

endwhile

average = total/count                       (1 mark)

print average, highest                     (1 mark) [6]
```